

# Dual Rubber Couplings **STEPFLEX**

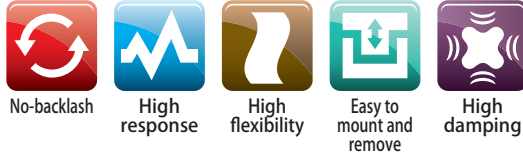

Max. nominal torque (N·m)	30
Bore ranges (mm)	φ 3 ~ 30
Operating temperature (°C)	-20 ~ 80
Driver	Servo motor, stepper motor
Application	Encoder, Semi-conductor manufacturing equipment, Actuator

## Couplings with High Damping Performance

Our newly developed laminated rubber element achieves high damping and low reaction force. These couplings for servo and stepper motors boast high damping performance. Their unitized construction with HNBR in the power-transmitting elements provides a backlash-free design. They dampen vibration faster than flexible couplings that use metal in their elastic components. This suppresses the resonance phenomenon that can occur with stepper motors, enabling resonance to be avoided over a wide range of operating speeds. It also provides stable high-speed control.



### Structure and Materials

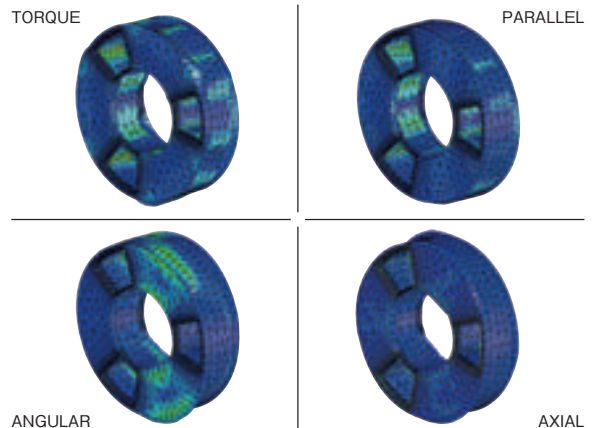
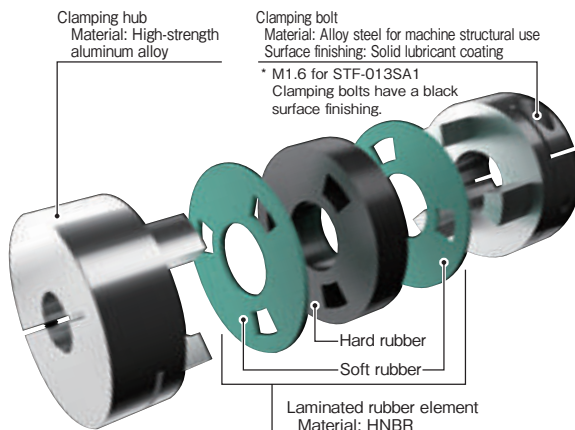

COUPLINGS

ETP BUSHINGS

ELECTROMAGNETIC CLUTCHES & BRAKES

SPEED CHANGERS & REDUCERS

INVERTERS

LINEAR SHAFT DRIVES

TORQUE LIMITERS

ROSTA

SERIES

Metal Disc Couplings	Metal Disc Couplings <b>SERVOFLEX</b>
	High-rigidity Couplings <b>SERVORIGID</b>
	Metal Slit Couplings <b>HELI-CAL</b>
	Metal Coil Spring Couplings <b>BAUMANNFLEX</b>
Metal Couplings	Pin Bushing Couplings <b>PARAFLEX</b>
	Link Couplings <b>SCHMIDT</b>
Rubber and Plastic Couplings	<b>Dual Rubber Couplings STEPFLEX</b>
	Jaw Couplings <b>MIKI PULLEY STARFLEX</b>
	Jaw Couplings <b>SPRFLEX</b>
	Plastic Bellows Couplings <b>BELLOWFLEX</b>
	Rubber and Plastic Couplings <b>CENTAFLEX</b>

Main Features

Excellent Damping Performance

The STEPFLEX laminated rubber element couplings provide better damping performance than standard metal disc couplings.

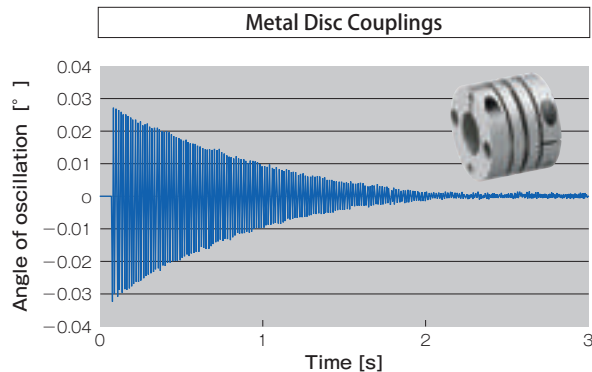
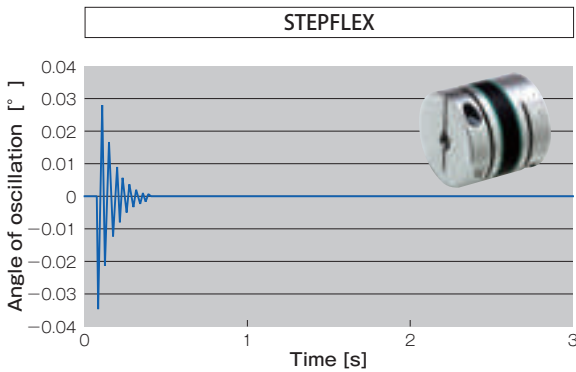

Shaft Counterforce Is Also Reduced

Use of a laminated rubber element with layers of varying hardnesses of rubber works to dramatically cut down on counterforces generated along the parallel and axial directions.

Comparison of counterforces for parallel misalignment

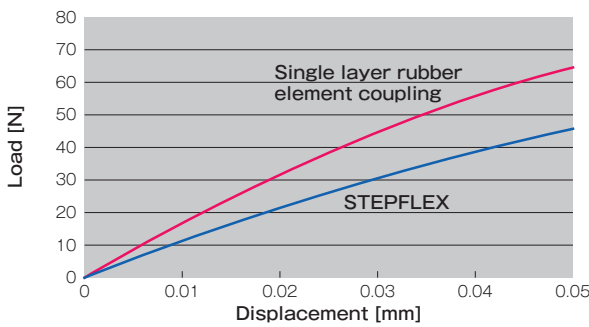

Comparison of counterforces along the axial direction

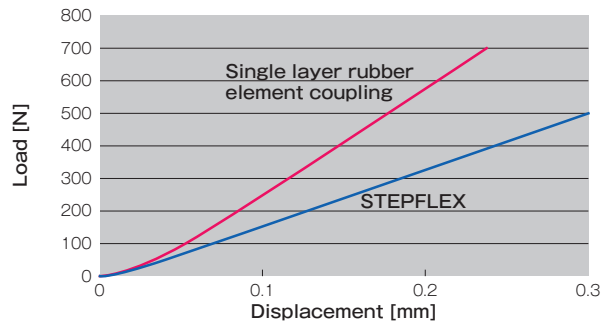

Enables Higher Gain

The damping effect can be seen clearly in the board chart, providing a bigger gain margin than metal plate-spring type couplings and helping to boost gain in the device.

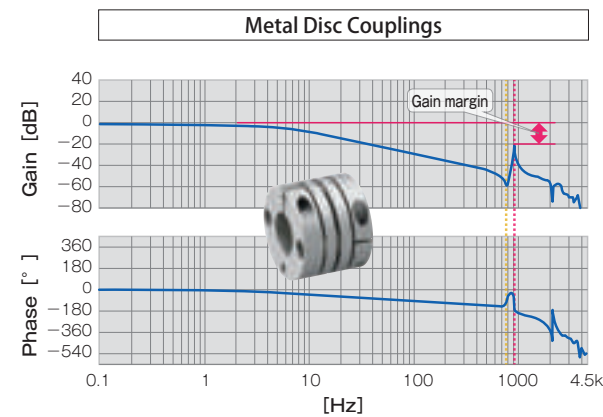
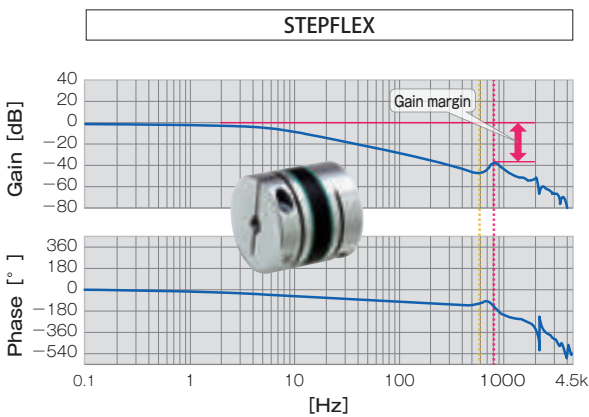

MODELS

STF

# STF Models

## Specifications

Model	Torque		Misalignment			Max. rotation speed [min <sup>-1</sup> ]	Torsional stiffness [N·m/rad]	Moment of inertia [kg·m <sup>2</sup> ]	Mass [kg]
	Nominal [N·m]	Max. [N·m]	Parallel [mm]	Angular [°]	Axial [mm]				
STF-013SA1	0.5	1	0.15	1.5	± 0.2	10000	15	0.11 × 10 <sup>-6</sup>	0.004
STF-016SA1	1	2	0.15	1.5	± 0.2	10000	27	0.31 × 10 <sup>-6</sup>	0.009
STF-019SA1	1.5	3	0.15	1.5	± 0.2	10000	38	0.70 × 10 <sup>-6</sup>	0.013
STF-024SA1	2.5	5	0.15	1.5	± 0.2	10000	127	1.89 × 10 <sup>-6</sup>	0.023
STF-029SA1	4	8	0.2	1.5	± 0.3	10000	201	4.40 × 10 <sup>-6</sup>	0.034
STF-034SA1	6	12	0.2	1.5	± 0.3	10000	371	9.77 × 10 <sup>-6</sup>	0.056
STF-039SA1	8.5	17	0.2	1.5	± 0.3	10000	485	21.13 × 10 <sup>-6</sup>	0.091
STF-044SA1	15	30	0.2	1.5	± 0.3	10000	996	37.30 × 10 <sup>-6</sup>	0.120
STF-056SA1	30	60	0.2	1.5	± 0.3	10000	2075	125.5 × 10 <sup>-6</sup>	0.251

\* Check the Max. Torque for the Shaft Diameter list as there may be limitations on the standard and maximum torque caused by the holding power of the coupling shaft section.

\* The max. rotation speed values do not take into account dynamic balance.

\* The static torsional stiffness values are analysis values for the element taken at a temperature of 20° C at maximum bore diameter.

\* The moment of inertia and mass are measured for the maximum bore diameter.

## Dimensions

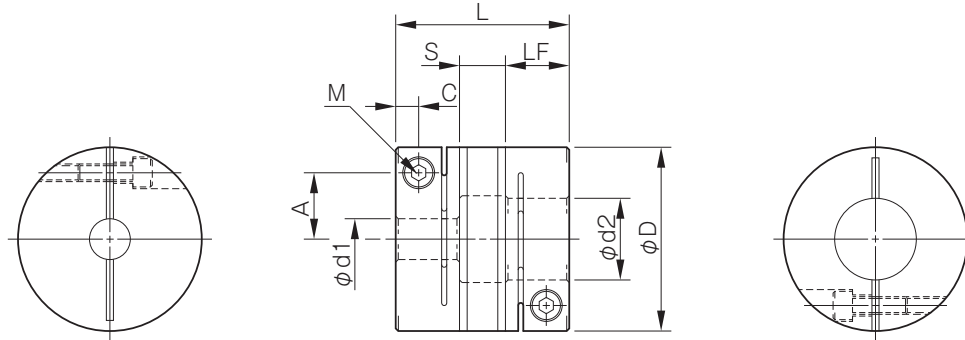

Model	d1 · d2 [mm]		D [mm]	L [mm]	LF [mm]	S [mm]	A [mm]	C [mm]	M Qty-Nominal diameter	Tightening torque [N·m]
	Min.	Max.								
STF-013SA1	3	5	13	18	6	6	3.9	2	1-M1.6	0.23 ~ 0.28
STF-016SA1	3	6	16	22	7.5	7	4.8	2.5	1-M2	0.4 ~ 0.5
STF-019SA1	3	8	19	25	9	7	5.8 (6)	3.15	1-M2.5 (M2)	1.0 ~ 1.1 (0.4 ~ 0.5)
STF-024SA1	5	10	24	27	9	9	8.7	3.15	1-M2.5	1.0 ~ 1.1
STF-029SA1	5	14	29	30	10	10	11	3.3	1-M2.5	1.0 ~ 1.1
STF-034SA1	5	16	34	34	12	10	12.5	3.75	1-M3	1.5 ~ 1.9
STF-039SA1	6	19	39	41	15.5	10	14	4.5	1-M4	3.4 ~ 4.1
STF-044SA1	8	24	44	48	15.5	17	17	4.5	1-M4	3.4 ~ 4.1
STF-056SA1	8	30	56	60	20.5	19	22	6	1-M5	7.0 ~ 8.5

\* The nominal diameter for the clamping bolt M is equal to the quantity minus the nominal diameter of the screw threads, where the quantity is for a hub on one side.

\* The figures in parentheses ( ) for the STF-019 are the values when d1 or d2 is ø8 mm.

\* The escape in the internal diameter of the element is equal to dimension d2 (large diameter) plus ø0.9 mm.

\* The rated dimension tolerance for countershafts is h7 class.

## Standard Bore Diameter

Model	Standard bore diameter d1 · d2 [mm]																								
	3	4	5	6	6.35	7	8	9	9.525	10	11	12	13	14	15	16	17	18	19	20	22	24	25	28	30
STF-013SA1	●	●	●																						
STF-016SA1	●	●	●	●																					
STF-019SA1	●	●	●	●	●	●	●	●																	
STF-024SA1			●	●	●	●	●	●	●	●	●														
STF-029SA1			●	●	●	●	●	●	●	●	●	●	●	●	●										
STF-034SA1			●	●	●	●	●	●	●	●	●	●	●	●	●	●	●								
STF-039SA1				●	●	●	●	●	●	●	●	●	●	●	●	●	●	●	●	●	●				
STF-044SA1							●	●	●	●	●	●	●	●	●	●	●	●	●	●	●	●	●	●	●
STF-056SA1								●	●	●	●	●	●	●	●	●	●	●	●	●	●	●	●	●	●

\* The bore diameters marked with ● are supported as standard bore diameter.

\* Depending on the bore diameter used, restrictions may apply to the standard and maximum torque as determined by the holding force in the shaft coupling. Check "Max. Torque for the Shaft Diameter".

COUPLINGS

ETP BUSHINGS

ELECTROMAGNETIC CLUTCHES & BRAKES

SPEED CHANGERS & REDUCERS

INVERTERS

LINEAR SHAFT DRIVES

TORQUE LIMITERS

ROSTA

### Max. Torque for the Shaft Diameter

Model	Standard bore diameter [mm] and max. torque for the shaft diameter [N · m]																											
	3	4	5	6	6.35	7	8	9	9.525	10	11	12	13	14	15	16	17	18	19	20	22	24	25	28	30			
STF-013SA1	0.10	0.25	0.40																									
STF-016SA1	0.5	0.6	0.7	0.8																								
STF-019SA1	0.8	1.2	1.6	1.9	1.9	2.3	0.8																					
STF-024SA1			1.6	2.1	2.1	2.6	3.3	4.0	4.0	4.7																		
STF-029SA1			1.8	2.2	2.2	2.7	3.4	4.1	4.1	4.8	5.5	6.3	7.8	8.0														
STF-034SA1			2.7	3.0	3.0	3.3	4.0	4.8	4.8	5.6	6.5	7.8	9.0	10.7	12.0	12.0												
STF-039SA1				3.4	3.4	4.0	5.0	6.1	6.1	7.1	8.2	9.3	10.4	11.5	12.8	14.0	15.3	16.6	17.0									
STF-044SA1								6.0	8.3	8.3	9.8	11.3	12.8	14.3	16.0	17.3	18.8	20.3	21.8	23.5	24.8	27.8	30.0					
STF-056SA1									10.7	11.9	11.9	13.4	14.9	16.3	17.8	18.7	20.8	22.2	23.7	25.2	27.0	32.0	41.9	52.0	56.3	60.0	60.0	

\* Check the above list as there may be limitations on the standard and maximum torque caused by the holding power of the coupling shaft section.  
 \* Standard or maximum torque with a limitation becomes the small diameter (d1) torque value. However, note that only in the instance that d1 or d2 for STF-019SA1 is ø8 mm, there is a decrease in the size of the clamping bolt, and the limit is 0.8 N·m.

### STF-019SA1 standard bore diameter and max. torque

d1-d2	Max. torque [N · m]	d1-d2	Max. torque [N · m]	d1-d2	Max. torque [N · m]	d1-d2	Max. torque [N · m]	d1-d2	Max. torque [N · m]	d1-d2	Max. torque [N · m]	d1-d2	Max. torque [N · m]
3B-3B	0.8	3B-4B	0.8	3B-5B	0.8	3B-6B	0.8	3B-6.35B	0.8	3B-7B	0.8	3B-8B	0.8
		4B-4B	1.2	4B-5B	1.2	4B-6B	1.2	4B-6.35B	1.2	4B-7B	1.2	4B-8B	0.8
				5B-5B	1.6	5B-6B	1.6	5B-6.35B	1.6	5B-7B	1.6	5B-8B	0.8
						6B-6B	1.9	6B-6.35B	1.9	6B-7B	1.9	6B-8B	0.8
								6.35B-6.35B	1.9	6.35B-7B	1.9	6.35B-8B	0.8
										7B-7B	2.3	7B-8B	0.8
												8B-8B	0.8

How to Place an Order

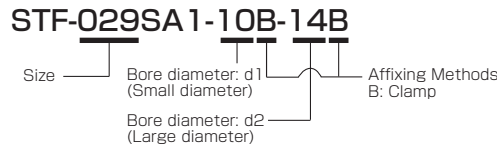

SERIES

- Metal Disc Couplings **SERVOFLEX**
- High-rigidity Couplings **SERVORIGID**
- Metal Slit Couplings **HELI-CAL**
- Metal Coil Spring Couplings **BAUMANNFLEX**
- Pin Bushing Couplings **PARAFLEX**
- Link Couplings **SCHMIDT**
- Dual Rubber Couplings **STEPFLEX**
- Jaw Couplings **MIKI PULLEY STARFLEX**
- Jaw Couplings **SPRFLEX**
- Plastic Bellows Couplings **BELLOWFLEX**
- Rubber and Plastic Couplings **CENTAFLEX**

MODELS

STF

# STF Models

## Items Checked for Design Purposes

### Special Items to Take Note of

You should note the following to prevent any problems.

- (1) Always be careful of parallel, angular, and axial misalignment.
- (2) Always tighten bolts with the specified torque.

### Precautions for Handling

- (1) Couplings are designed for use within an operating temperature from -20°C to 80°C. Avoid using it under the environment where water, oil, acid, alkali, ozone, chemical agent, etc. are used. Use and storage in direct sunlight may shorten element service life, so cover elements appropriately.
- (2) Do not tighten up clamping bolts until after inserting the mounting shaft.
- (3) Mounting shaft is assumed to be a round shaft.

### Mounting

- (1) Check that coupling clamping bolts have been loosened and remove any rust, dust, oil residue, etc. from inner diameter surfaces of the shaft and couplings. In particular, never allow oil or grease containing antifriction or other agent (molybdenum-, silicon-, or fluorine-based), which would dramatically affect the friction coefficient, to contact the surface.
- (2) Be careful when inserting the couplings into the shaft so as not to apply excessive force of compression or tensile force to the element. Be particularly careful not to apply excessive compressing force needlessly when inserting couplings into the paired shaft after attaching the couplings to the motor.
- (3) With two of the clamping bolts loosened, make sure that couplings move gently along the axial and rotational directions. Readjust the centering of the two shafts if the couplings fail to move smoothly enough. This method is recommended as a way to easily check the concentricity of the left and right sides. If unable to use the same method, check the mounting accuracy using machine parts quality control procedures or an alternative method.

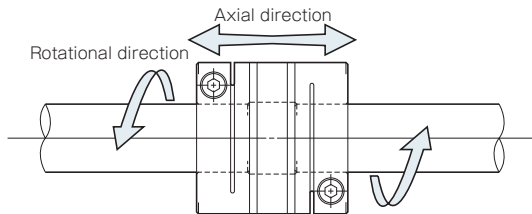

- (4) As a general rule, round shafts are to be used for the paired mounting shaft. If needing to use a shaft with a different shape, be careful not to insert it into any of the locations indicated in the diagrams below. (Grayed areas indicate areas wherein clamping hub shifts when clamped. Do not allow keyways, D-shaped cuts, or other insertions in these areas.) Placing the shaft in an undesirable location may cause the couplings to break or lead to a loss in shaft holding power. It is recommended that you use only round shafts to ensure full utilization of the entire range of coupling performance.

#### Proper mounting examples

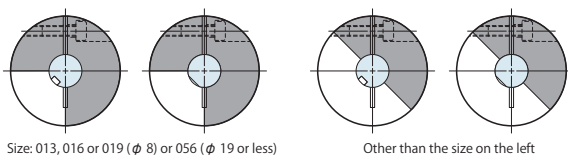

#### Poor mounting examples

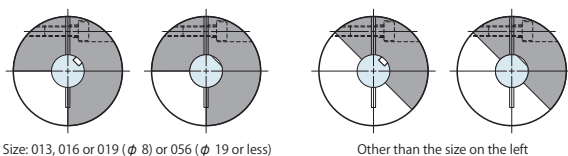

- (5) Insert and mount each shaft far enough in that the paired mounting shaft touches the shaft along the entire length of the clamping hub of the coupling (LF dimension), as shown in the diagram below, and does not interfere with the elements or the other shaft. In addition, restrict the dimension between clamping hub faces (S dimension) within the allowable error range for axial displacement with respect to a reference value. Note that the tolerance values were calculated based on the assumption that both the level of parallel misalignment and angular deflection are zero. Adjust to keep this value as low as possible.

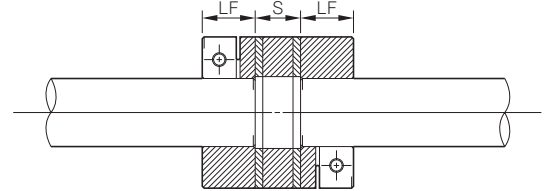

Model	LF [mm]	S [mm]
STF-013SA1	6	6
STF-016SA1	7.5	7
STF-019SA1	9	7
STF-024SA1	9	9
STF-029SA1	10	10
STF-034SA1	12	10
STF-039SA1	15.5	10
STF-044SA1	15.5	17
STF-056SA1	20.5	19

- (6) Check to make sure that no compression or tensile force is being applied along the axial direction before tightening up the two clamping bolts. Use a calibrated torque wrench to tighten the clamping bolts to within the tightening torque range listed below.

Model	Clamping bolts	Tightening torque [N·m]
STF-013SA1	M1.6	0.23 ~ 0.28
STF-016SA1	M2	0.4 ~ 0.5
STF-019SA1	M2.5 (M2)	1.0 ~ 1.1 (0.4 ~ 0.5)
STF-024SA1	M2.5	1.0 ~ 1.1
STF-029SA1	M2.5	1.0 ~ 1.1
STF-034SA1	M3	1.5 ~ 1.9
STF-039SA1	M4	3.4 ~ 4.1
STF-044SA1	M4	3.4 ~ 4.1
STF-056SA1	M5	7.0 ~ 8.5

\* Use M2 bolts on STF-019SA models with holes with a diameter of ø8 mm.  
\* The start and end numbers for the tightening torque ranges are between the minimum and maximum values. Tighten bolts to a tightening torque within the specified range for the model used.

### Suitable Torque Screwdriver

Nominal bolt diameter	Tightening torque [N·m]	Torque screwdriver	Hexagon bit	Coupling size
M1.6	0.23 ~ 0.28	CN30LTDK	CB1.5mm	013
M2	0.4 ~ 0.5	CN60LTDK	SB1.5mm	016,019
M2.5	1.0 ~ 1.1	CN120LTDK	SB2mm	019,024,029
M3	1.5 ~ 1.9	CN200LTDK	SB2.5mm	034
M4	3.4 ~ 4.1	CN500LTDK	SB3mm	039,044
M5	7.0 ~ 8.5	N10LTDK	SB4mm	056

### Clamping Bolts

Use Miki Pulley-specified clamping bolts because they are processed with solid lubrication films (except for STF-013SA1 M1.6). Applying adhesives to prevent loosening, oil, or the like to a clamping bolt will alter torque coefficients due to those lubricating components, creating excessive axial forces and potentially damaging the clamping bolt or coupling. Be particularly careful to never use liquid anaerobic screw fixatives, as they have adverse effects on the rubber body.

## Points to Consider Regarding the Feed Screw System

STEPFLEX coupling STF model is the coupling greatly controls and prevents the resonance of stepper motor and oscillation of servo motor by utilizing the damping of laminated rubber element. If more detailed review is required, make a review by paying attention to the following points.

Please contact Miki Pulley with any questions regarding servo motor oscillation or stepper motor resonance.

### Stepper motor resonance

Stepper motors resonate at certain rotation speeds due to the pulsation frequency of the stepper motor and the torsional natural frequency of the system as a whole. To avoid resonance, either the resonant rotation speed must be simply skipped or the torsional natural frequency considered at the design stage.

### Servo motor oscillation

Gain adjustment on the servo motor may cause the servo motor to oscillate. Oscillation in the servo motor during operation can cause problems particularly with the overall natural frequency and electrical control systems of the feed screw system.

In order for these issues to be resolved, the torsional stiffness for the coupling and feed screw section and the moment of inertia and other characteristics for the system overall will need to be adjusted and the torsional natural frequency for the mechanical system raised or the tuning function (filter function) for the electrical control system in the servo motor adjusted during the design stage.

### How to find the natural frequency of a feed screw system

- Select a coupling based on the nominal and maximum torque of the servo motor or stepper motor.
- Find the overall natural frequency,  $N_f$ , from the torsional stiffness of the coupling and feed screw,  $\kappa$ , the moment of inertia of the driving side,  $J_1$ , and the moment of inertia of driven side,  $J_2$ , for the feed screw system shown below.

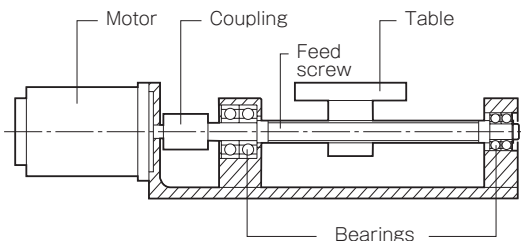

$$N_f = \frac{1}{2\pi} \sqrt{\kappa \left( \frac{1}{J_1} + \frac{1}{J_2} \right)}$$

- $N_f$ : Overall natural frequency of a feed screw system [Hz]
- $\kappa$ : Torsional stiffness of the coupling and feed screw [N·m/rad]
- $J_1$ : Moment of inertia of driving side [kg·m<sup>2</sup>]
- $J_2$ : Moment of inertia of driven side [kg·m<sup>2</sup>]

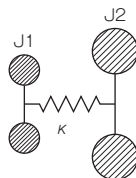

## Selection Procedures

- Find the torque,  $T_a$ , applied to the coupling using the output capacity,  $P$ , of the driver and the usage rotation speed,  $n$ .

$$T_a [\text{N}\cdot\text{m}] = 9550 \times \frac{P [\text{kW}]}{n [\text{min}^{-1}]}$$

- Determine the service factor  $K$  from the usage and operating conditions, and find the corrected torque,  $T_d$ , applied to the coupling.

$$T_d [\text{N}\cdot\text{m}] = T_a \times K_1 \times K_2 \times K_3 \times K_4$$

### Service factor based on load property: K1

Load properties	Constant	Vibrations: Small	Vibrations: Medium	Vibrations: Large
$K_1$	1.0	1.25	1.75	2.25

### Service factor based on operating time: K2

Hrs./day	~ 8	~ 16	~ 24
$K_2$	1.0	1.12	1.25

### Service factor based on starting/braking frequency: K3

Times/min.	~ 60	~ 120	~ 360	Over 360
$K_3$	1.0	1.3	1.5	*

\* Items marked with asterisks require consultations.

### Service factor based on operating temperature: K4

Temperature [°C]	-20 ~ 30	30 ~ 40	40 ~ 50	50 ~ 60	60 ~ 70	70 ~ 80
$K_4$	1.0	1.1	1.2	1.4	1.6	1.8

- Set the size so that the standard coupling torque  $T_n$  is at least equal to the corrected torque,  $T_d$ .

$$T_n \geq T_d$$

- Select a size that results in a maximum torque,  $T_m$ , for the coupling that is at least equal to the peak torque,  $T_s$ , generated by the driver, follower or both. Maximum torque refers to the maximum amount of torque that can be applied for a set amount of time considering eight hours of operation per day and up to around ten instances.

$$T_m \geq T_s$$

- When the required shaft diameter exceeds the maximum bore diameter of the selected size, select a suitable coupling. When using a clamping hub, the bore diameter may restrict the transmission torque. For that reason, check that the clamping-hub shaft holding force of the selected coupling size is at least equal to the peak torque,  $T_s$ , applied to the coupling.

- Contact Miki Pulley for assistance with any device experiencing extreme periodic vibrations.

## Guide for Selecting Size

Displays under the guide of suitable size for STEPFLEX coupling measured from the result of rated output of general stepper motor and servo motor. The torque characteristics of servo motors vary between manufacturers, so check the specifications in the manufacturer catalog before finalizing a coupling size selection.

Stepper motor	Rated output of servo motor	Model
□ 20 ~	5W · 10W	STF-013SA1
□ 30 ~	20W · 30W	STF-016SA1
□ 40 ~	50W · 100W	STF-019SA1
□ 40 ~	100W	STF-024SA1
□ 50 ~	200W	STF-029SA1
□ 60 ~	400W	STF-034SA1
□ 85 ~	750W	STF-039SA1
□ 85 ~	1kW	STF-044SA1
□ 85 ~	1.5kW	STF-056SA1

### COUPLINGS

ETP BUSHINGS

ELECTROMAGNETIC CLUTCHES & BRAKES

SPEED CHANGERS & REDUCERS

INVERTERS

LINEAR SHAFT DRIVES

TORQUE LIMITERS

ROSTA

### SERIES

Metal Disc Couplings	SERVOFLEX
High-rigidity Couplings	SERVORIGID
Metal Slit Couplings	HELI-CAL
Metal Coil Spring Couplings	BAUMANNFLEX
Pin Bushing Couplings	PARAFLEX
Link Couplings	SCHMIDT
Dual Rubber Couplings	STEFLEX
Jaw Couplings	MIKI PULLEY STARFLEX
Jaw Couplings	SPRFLEX
Plastic Bellows Couplings	BELLOWFLEX
Rubber and Plastic Couplings	CENTAFLEX

### MODELS

STF